

Directional spool valves, directly operated, with manual and fluid logics actuation

Type WMM, WN and WP

RE 22334

Edition: 2013-04

Replaces: 22331



- ▶ Size 10
- ▶ Component series 5X
- ▶ Maximum operating pressure 350 bar [5076 psi]
- ▶ Maximum flow 160 l/min [42.3 US gpm]

Features

- ▶ 4/3-, 4/2- or 3/2-way version
- ▶ Porting pattern according to ISO 4401-05-04-0-05 and NFPA T3.5.1 R2-2002 D05
- ▶ Types of actuation:
 - Hand lever
 - Pneumatic
 - Hydraulic

Contents

Features	1
Ordering code	2
Symbols	3
Types of actuation	4, 5
Function, section	6
Technical data	7
Characteristic curves	8
Performance limits	9, 10
Dimensions	11 ... 14
More information	14

Ordering code

01	02	03	04	05	06	07	08	09	10	11
		10		5X	/		/			*

01	3 main ports	3
	4 main ports	4

Types of actuation

02	- Manual	
	Hand lever	WMM
	- Fluidic	
	Pilot pressure 1.5 ... 10 bar [22 ... 145 psi]	WN
	Pilot pressure 8 ... 160 bar [116 ... 2321 psi]	WP

03	Size 10	10
----	---------	-----------

04	Symbols e.g. C, E, EA, EB, etc; possible versions see page 3 ... 5	
----	--	--

05	Component series 50 ... 59 (50 ... 59: Unchanged installation and connection dimensions)	5X
----	--	-----------

06	With spring return	no code
	Without spring return (not for valves with 3 switching positions and version "WMM")	O
	With detent (not for versions "WN" and "WP")	F
	Without spring return with detent (not for valves with 3 switching positions and version "WMM")	OF

Corrosion protection

07	Standard corrosion protection	no code
	Improved corrosion protection (720 h salt spray test according to EN ISO 9227; only version "WMM")	J4

Throttle insert ¹⁾

08	Without throttle insert	no code		
	With throttle insert:			
	Connection	Throttle Ø in mm [inch]		
		0.8 [0.031]	1.0 [0.039]	1.2 [0.047]
	P	= B08	= B10	= B12
	A	= H08	= H10	= H12
	B	= R08	= R10	= R12
	A and B	= N08	= N10	= N12
T ²⁾	= X08	= X10	= X12	
Further throttle insert diameters upon request.				

Seal material

09	NBR seals	M
	FKM seals	V
	Seals for HFC hydraulic fluids	MH
	Attention: Observe compatibility of seals with hydraulic fluid used!	

Pilot oil port

10	Whitworth pipe thread G1/4	-
	UNF thread 7/16" - 20 UNF (only versions "WN" and "WP")	/12
11	Further details in the plain text	

¹⁾ If the admissible valve performance limits are exceeded, throttle inserts must be installed (performance limits see page 9).

²⁾ If throttle inserts are used in channel T, the pressure in the working ports and for connection to the tank chambers must not exceed 210 bar.

Symbols

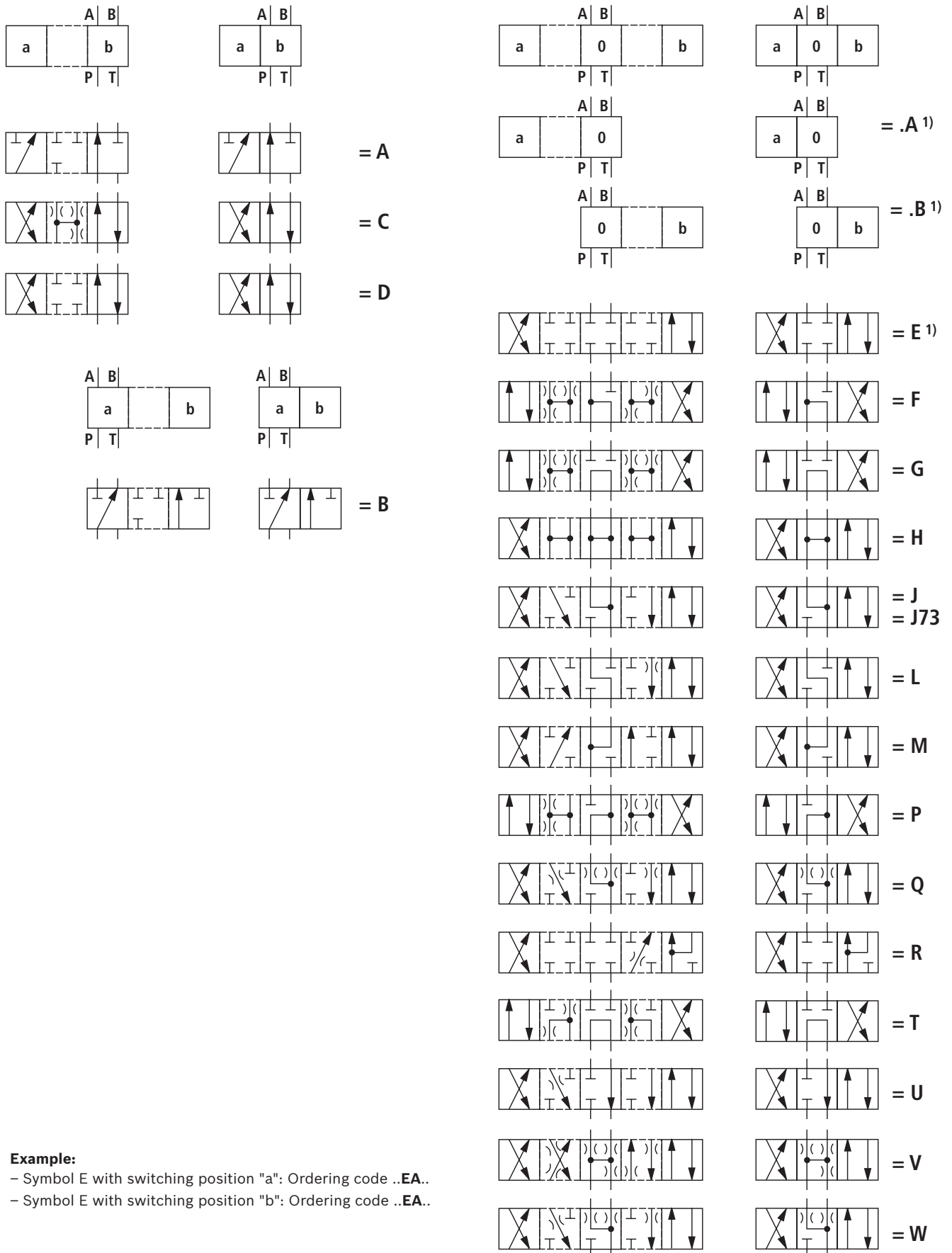

1) **Example:**
 - Symbol E with switching position "a": Ordering code ..EA..
 - Symbol E with switching position "b": Ordering code ..EA..

Types of actuation: Type WMM

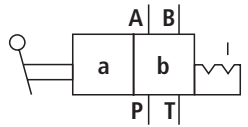
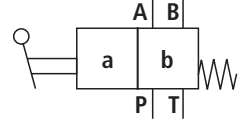
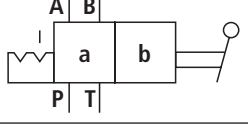
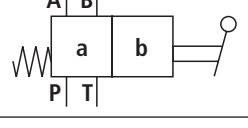
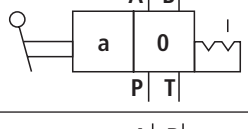
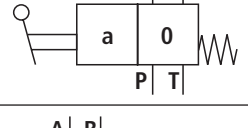
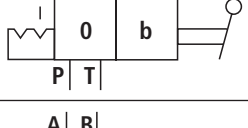
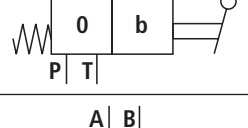
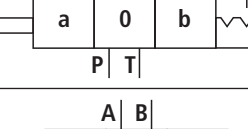
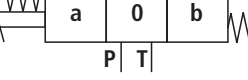
Symbol	Ordering code		Type of actuation	
	Actuating side	Detent	Hand lever	
A, C, D		../F..		2)
				2)
B		../F..		3)
				3)
E, F, G, H, J, J73, L, M, P, Q, R, T, U, V, W	"a" 1) = .A	../F..		2)
				2)
	"b" 1) = .B	../F..		3)
				3)
		../F..		4)
				4)

1) See symbols on page 3
 2) See pos. 2, page 11
 2) See pos. 1, page 11
 2) See pos. 3, page 11

Courtesy of CMA/Flodyne/Hydradyne • Motion Control • Hydraulic • Pneumatic • Electrical • Mechanical • (800) 426-5480 • www.cmafah.com

Types of actuation: WN and WP

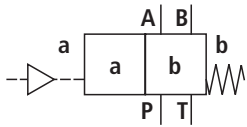
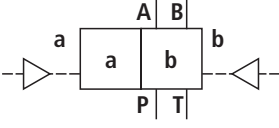
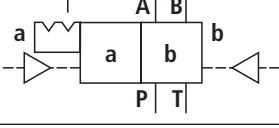
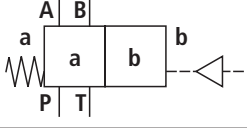
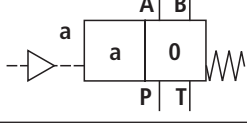
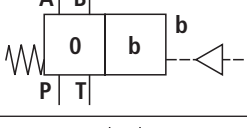
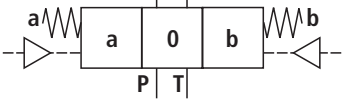
Symbol	Ordering code Actuating side	Detent	Type of actuation Fluidic
A, C, D			
		../O..	
		../OF..	
B			
E, G, H, J, L, U	"a" ¹⁾ = .A		
	"b" ¹⁾ = .B		
			

¹⁾ See symbols on page 3

Function, section

Valves of type WMM are manually actuated directional spool valves, valves of type WN and WP are fluidically actuated directional spool valves. They control the start, stop and direction of a flow.

The directional valves basically consist of housing (1), one type of actuation (2.1) (hand lever) or two types of actuation (2.2) (hydraulic, pneumatic)

actuation cylinder), control spool (3), and one or two return springs (4).

When de-energized, the control spool (3) is held in the central position or in the initial position by the return springs (4) (except for version "O").

The control spool (3) is moved to the desired spool position by means of the types of actuation.

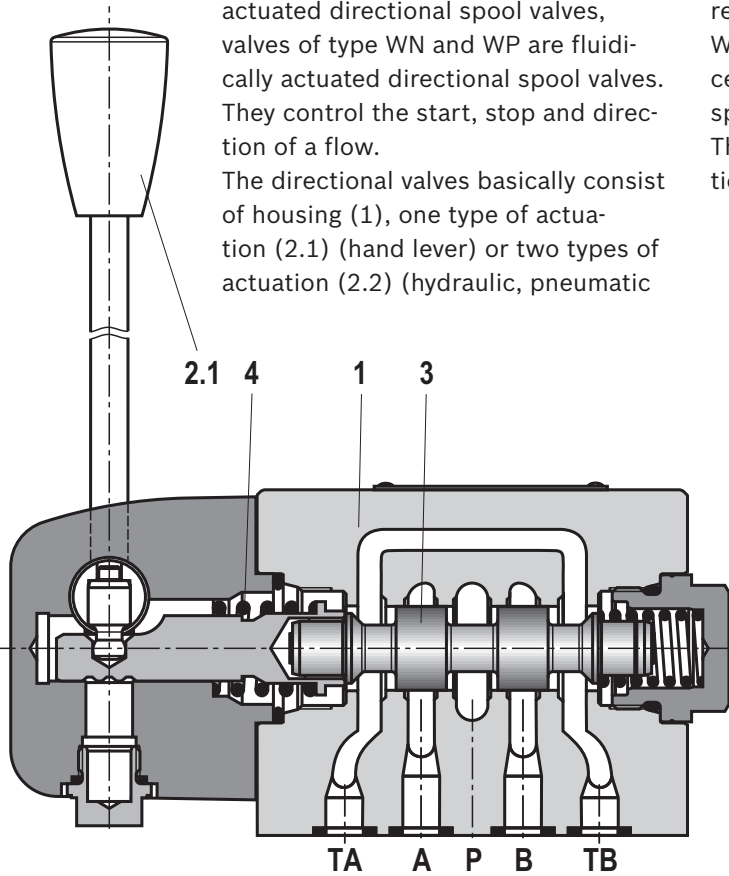

Type 4WMM 10 E5X/...

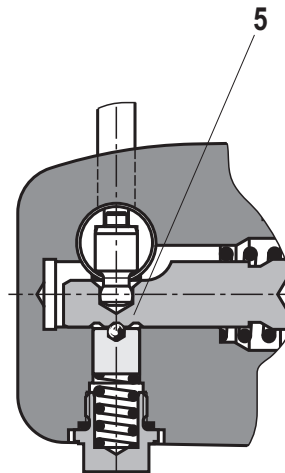

Type 4WMM 10 D5X/F/...
(with detent)

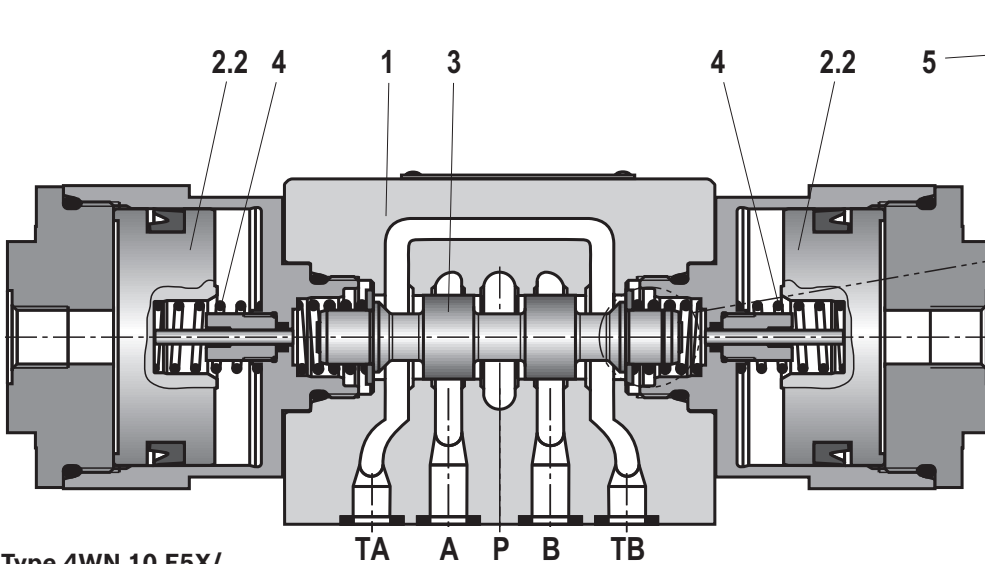

Type 4WN 10 E5X/...

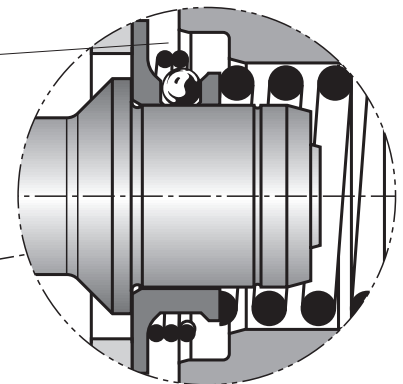

Type 4WN 10 D5X/OF...

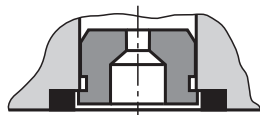

Throttle insert

The use of a throttle insert is required when, due to prevailing operating conditions, flows occur during the switching processes which exceed the performance limit of the valve.

Courtesy of CMA/Flodyne/Hydradyne • Motion Control • Hydraulic • Pneumatic • Electrical • Mechanical • (800) 426-5480 • www.cmafh.com

Technical data

(for applications outside these parameters, please consult us!)

general					
Type		WN	WP	WMM	
Weight	- 1 actuation cylinder	kg [lbs]	3.4 [7.5]	2.9 [6.4]	3.6 [7.9]
	- 2 actuation cylinder	kg [lbs]	4.8 [10.6]	3.7 [8.2]	
Actuating force	- With detent "F"	N [lbf]	-	-	30 ... 40 [6.7... 9.0]
	- With spring return	N [lbf]	-	-	18 ... 20 [4.1... 4.5]
Installation position		Any			
Ambient temperature range		°C [°F]	-20 ... +70 [-4... +158] (NBR seals) -15 ... +70 [-59... +158] (FKM seals)		
Storage temperature range		°C [°F]	-20 ... +50 [-4... +122]		

hydraulic					
Maximum operating pressure	- Ports A, B, P	bar [psi]	350 [5076]		
	- Port T	bar [psi]	210 [3050] Tank pressure (standard) With symbols A or B, port T must be used as a leakage port if the operating pressure exceeds the admissible tank pressure.		
Pilot pressure ¹⁾		bar [psi]	1.5 ... 10 [22 ... 145 psi]	8 ... 160 [116 ... 2321 psi]	-
Maximum flow		l/min [US gpm]	160 [42.3]		
Pilot volume		cm ³ [inch ³]	23.7 [1.45]	6.9 [0.42]	-
Hydraulic fluid			See table below		
Hydraulic fluid temperature range (at the valve working ports)		°C [°F]	-20 ... +80 [-4... +176] (NBR seals) -15 ... +80 [-59... +176] (FKM seals)		
		mm ² /s [SUS]	2.8 ... 500 [35... 2320]		
Maximum permitted degree of contamination of the hydraulic fluid - cleanliness class according to ISO 4406 (c)			Class 20/18/15 ²⁾		

Hydraulic fluid	Classification	Suitable sealing materials	Standards
Mineral oils and related hydrocarbons	HL, HLP, HLPD, HVLP, HVLDP	NBR, FKM	DIN 51524
Bio-degradable	- insoluble in water	HETG	VDMA 24568
		HEES	
	- soluble in water	HEPG	VDMA 24568
Flame-resistant	- water-free	HFDU, HFDR	ISO 12922
	- containing water	HFC (Fuchs Hydrotherm 46M, Petrofer Ultra Safe 620)	ISO 12922

**Important information on hydraulic fluids**

- ▶ For more information and data on the use of other hydraulic fluids, refer to data sheet 90220 or contact us.
- ▶ There may be limitations regarding the technical valve data (temperature, pressure range, life cycle, maintenance intervals, etc).

▶ Flame-resistant – contains water:

- Maximum pressure differential per control edge 50 bar
- Pressure pre-loading at the tank port > 20% of the pressure differential, otherwise increased cavitation
- Life cycle as compared to operation with mineral oil HL, HLP 50 to 100%

¹⁾ The information given only applies if the actuation pressure is applied directly to the valve.

²⁾ The cleanliness classes specified for the components must be adhered to in hydraulic systems. Effective filtration prevents faults and at the same time increases the life cycle of the components. To select filters, see www.boschrexroth.com/filter.

Characteristic curves

(measured with HLP46, $\vartheta_{oil} = 40 \pm 5 \text{ }^\circ\text{C} [104 \pm 9 \text{ }^\circ\text{F}]$)

Δp - q_v characteristic curve

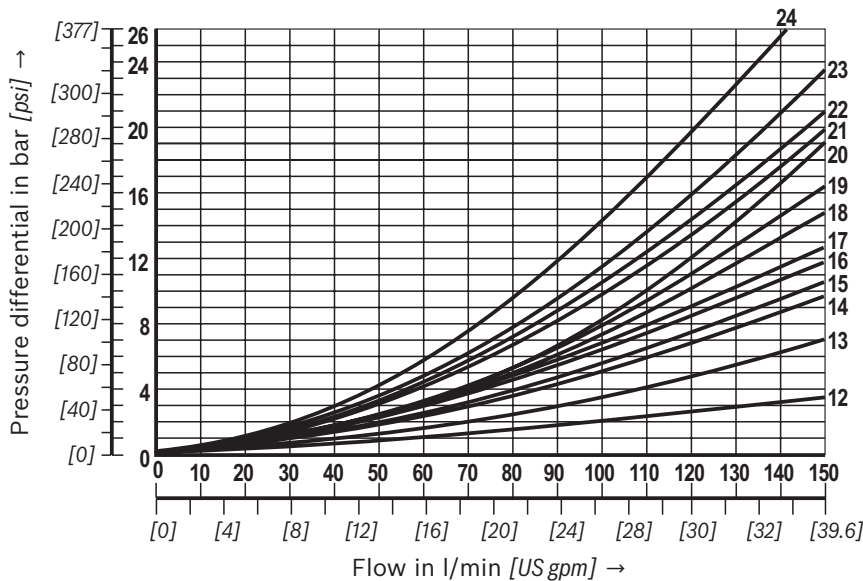
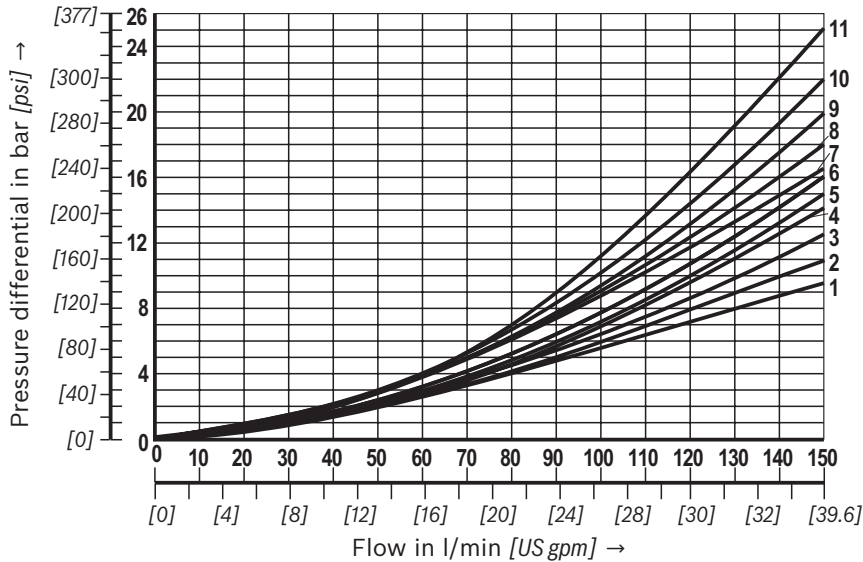

Symbol	Direction of flow			
	P - A	P - B	A - T	B - T
A; B	6	6	-	-
C	1	2	5	7
D	2	2	5	7
E	17	16	19	21
F	2	3	22	23
G	4	4	24	24
H	14	14	20	21
J	3	3	9	11
J73	22	21	23	24
L	3	3	9	9
M	14	14	6	8
P	17	14	20	23
Q	16	17	4	8
R	18	21	18	24
T	18	4	10	24
U	3	3	6	11
V	17	17	18	20
W	Upon request			

Central position:

Symbol	Direction of flow				
	P - A	P - B	B - T	A - T	P - T
H	12	12	13	13	15

Performance limits

(measured with HLP46, $\vartheta_{oil} = 40 \pm 5 \text{ }^\circ\text{C}$ [$104 \pm 9 \text{ }^\circ\text{F}$])

Notice!

The specified performance limits are valid for operation with two directions of flow (e. g. from P to A and simultaneous return flow from B to T).

Due to the flow forces acting within the valves, the

admissible switching power limit may be considerably lower with only one direction of flow (e. g. from P to A while port B is blocked).

In such cases, please consult us.

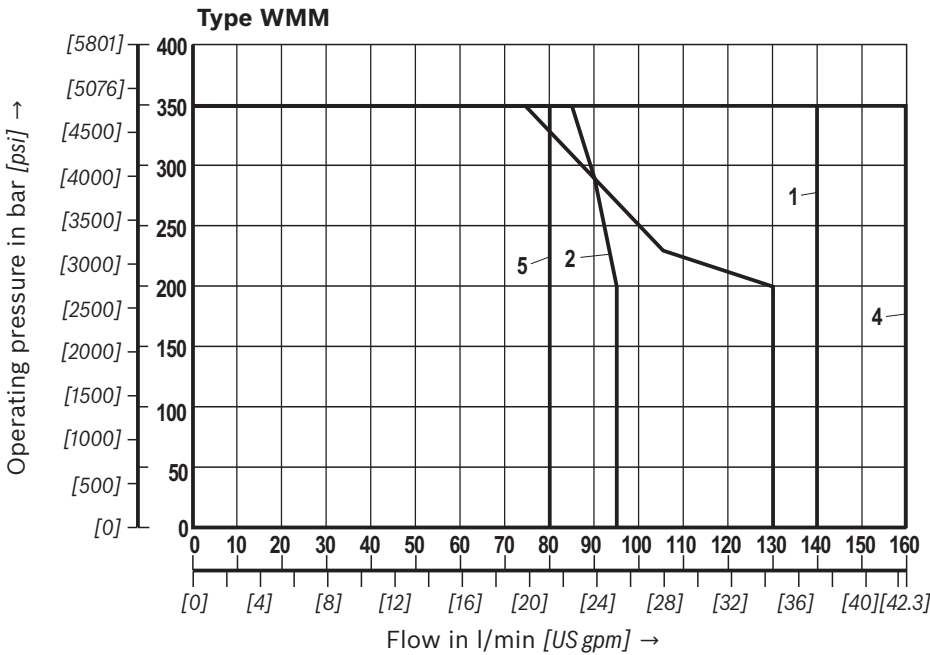

With spring return "-"

Characteristic curve	Symbol
1	C, D, E, J, J73, L, M, Q, U, V, W
2	H
3	T, G

With detent "F"

Characteristic curve	Symbol
4	C, D, E, J, J73, L, M, Q, U
5	T, G, H

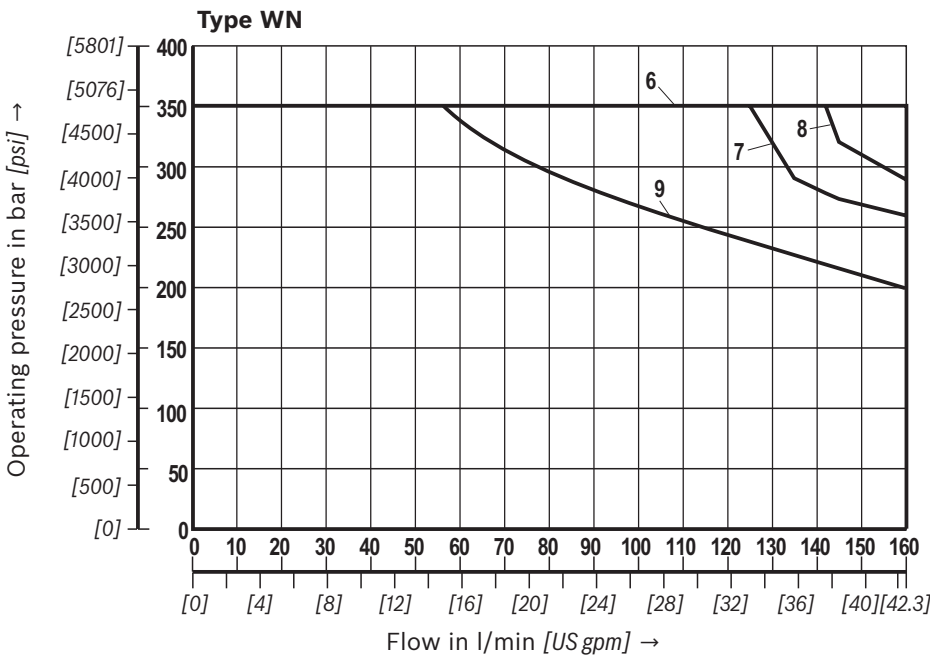

Characteristic curve	Symbol
6	C, C/OF, D, D/OF, E, J, L, M, U
7	H
8	G
9	A, B

Performance limits

(measured with HLP46, $\vartheta_{oil} = 40 \pm 5 \text{ }^\circ\text{C}$ [$104 \pm 9 \text{ }^\circ\text{F}$])

Notice!

The specified performance limits are valid for operation with two directions of flow (e. g. from P to A and simultaneous return flow from B to T).

Due to the flow forces acting within the valves, the admissible switching power limit may be considerably

lower with only one direction of flow (e. g. from P to A while port B is blocked).
In such cases, please consult us.

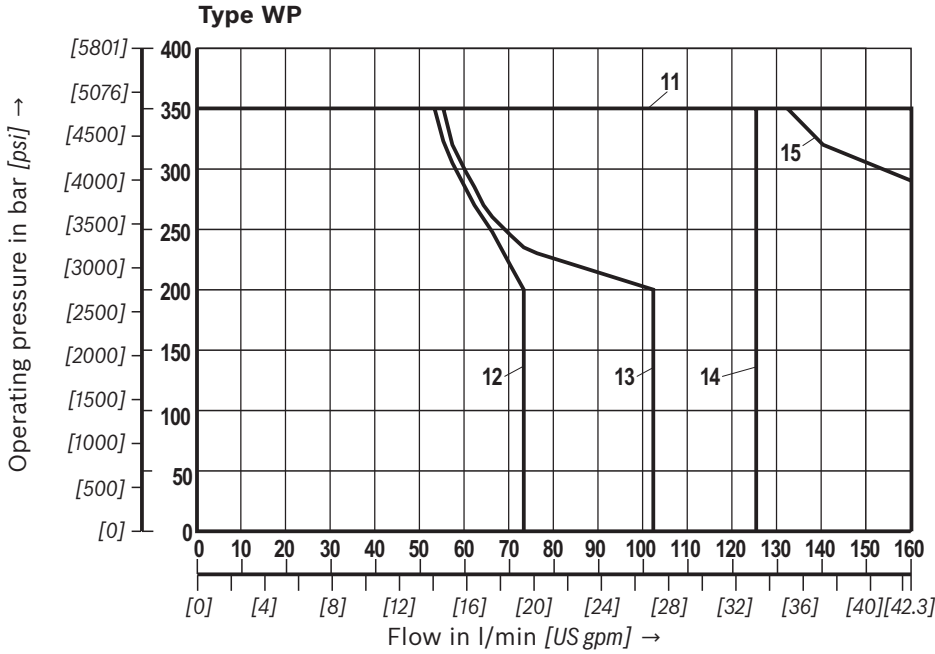

Characteristic curve	Symbol
11	C, C/OF, D, D/OF, E, J, L, M, U
12	B
13	A
14	G
15	H

Dimensions: Type WM
(dimensions in mm [inch])

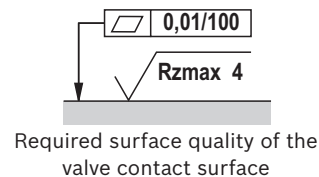
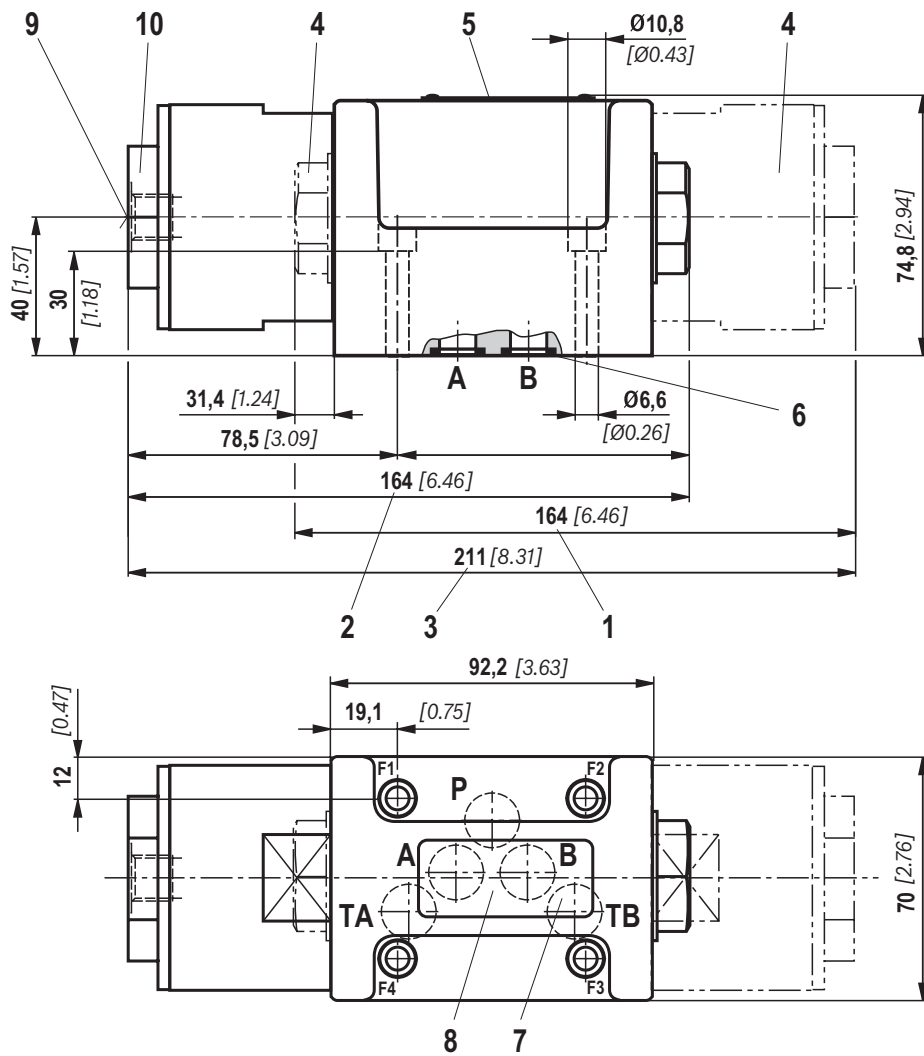

- 1 Valves with 2 switching positions, symbol B and .B
- 2 Valves with 2 switching positions, symbol A, C, D .A
- 3 Valves with 3 switching positions
- 4 Cover and plug screw
- 5 Name plate
- 6 Identical seal rings for port A, B, P, TA, TB
- 7 Additional port TB can optionally be used
- 8 Porting pattern according to ISO 4401-05-04-0-05 and NFPA T3.5.1 R2-2002 D05
- 9 Pilot oil port G1/4 (version "-")
Pilot oil port 7/16" - 20 UNF (version "/12")
- 10 Socket

- Notes**
- ▶ Deviating from ISO 4401, port T is called TA in this data sheet; port T1 is called TB.
 - ▶ The dimensions are nominal dimensions which are subject to tolerances.
 - ▶ When screwing in/releasing the connection tube on the pilot oil port (9), the bushing (10) must be secured against twisting by using an open-end wrench.

Valve mounting screws and subplates see page 14.

Dimensions: Type WP
(dimensions in mm [inch])

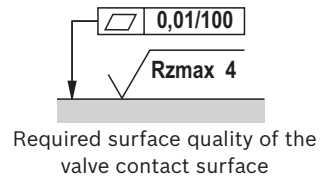
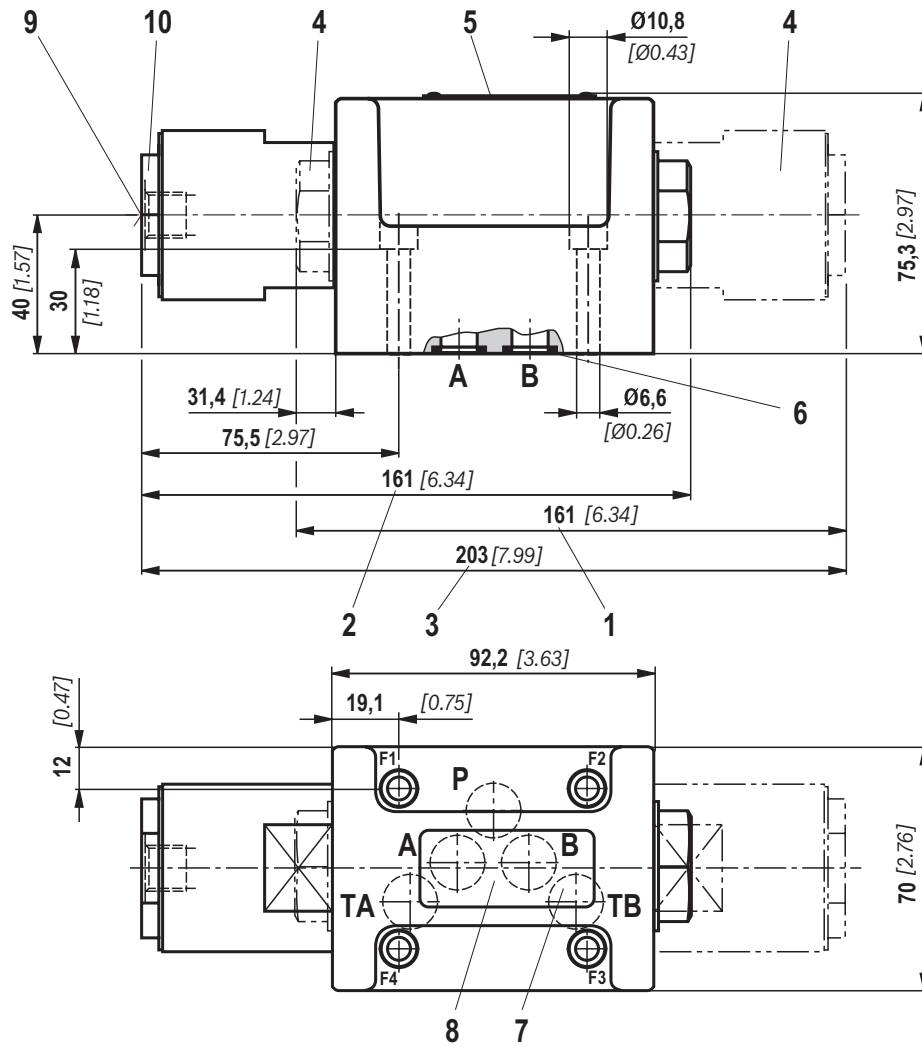

- 1 Valves with 2 switching positions, symbol B and .B
- 2 Valves with 2 switching positions, symbol A, C, D, EA...
- 3 Valves with 3 switching positions
- 4 Cover and plug screw for valves with 2 switching positions, symbol B, Y, EB...
- 5 Name plate
- 6 Identical seal rings for port A, B, P, TA, TB
- 7 Additional port TB can optionally be used
- 8 Porting pattern according to ISO 4401-05-04-0-05 and NFPA T3.5.1 R2-2002 D05
- 9 Metric pilot oil port: G1/4
UNC pilot oil port: 7/16" - 20 UNF
- 10 Socket

Notes

- ▶ Deviating from ISO 4401, port T is called TA in this data sheet; port T1 is called TB.
- ▶ The dimensions are nominal dimensions which are subject to tolerances.
- ▶ When screwing in/releasing the connection tube on the pilot oil port (9), the bushing (10) must be secured against twisting by using an open-end wrench.

Valve mounting screws and subplates see page 14.

Dimensions

Subplates according to data sheet 45054 (separate order)

G 66/01 (G3/8) ¹⁾

G 67/01 (G1/2) ¹⁾

G 534/01 (G3/4) ¹⁾

G 66/12 (SAE-6; 9/16-18) ²⁾

G 67/12 (SAE-8; 3/4-16) ²⁾

G 534/12 (SAE-12; 1-1/16-12) ²⁾

1) For version "J4" upon request

2) Upon request

Valve mounting screws (separate order)

4 metric hexagon socket head cap screws

ISO 4762 - M6 x 40 - 10.9-flZn-240h-L

(Friction coefficient $\mu_{\text{total}} = 0.09$ to 0.14);

Tightening torque $M_A = 12.5$ Nm [9.2 ft-lbs] $\pm 10\%$,

material no. **R913000058**

or

4 hexagon socket head cap screws

ISO 4762 - M6 x 40 - 10.9 (self procurement)

(Friction coefficient $\mu_{\text{total}} = 0.12$ to 0.17);

Tightening torque $M_A = 15.5$ Nm [11.4 ft-lbs] $\pm 10\%$

4 UNC hexagon socket head cap screws

1/4-20 UNC x 1-1/2" ASTM-A574

(Friction coefficient $\mu_{\text{total}} = 0.19$ to 0.24);

Tightening torque $M_A = 25$ Nm [18.4 ft-lbs] $\pm 15\%$,

(Friction coefficient $\mu_{\text{total}} = 0.12$ to 0.17);

Tightening torque $M_A = 19$ Nm [14.0 ft-lbs] $\pm 10\%$,

material no. **R978800710**

With different friction coefficients, the tightening torques are to be adjusted accordingly.

More information

- ▶ Subplates
- ▶ Hydraulic fluids on mineral oil basis
- ▶ General product information on hydraulic products
- ▶ Installation, commissioning and maintenance of industrial valves
- ▶ Hydraulic valves for industrial applications
- ▶ Selection of the filters

Data sheet 45054

Data sheet 90220

Data sheet 07008

Data sheet 07300

Data sheet 07600-B

www.boschrexroth.com/filter

Bosch Rexroth AG
Hydraulics
Zum Eisengießer 1
97816 Lohr am Main, Germany
Phone +49 (0) 93 52/18-0
documentation@boschrexroth.de
www.boschrexroth.de

© This document, as well as the data, specifications and other information set forth in it, are the exclusive property of Bosch Rexroth AG. It may not be reproduced or given to third parties without its consent. The data specified above only serve to describe the product. No statements concerning a certain condition or suitability for a certain application can be derived from our information. The information given does not release the user from the obligation of own judgment and verification. It must be remembered that our products are subject to a natural process of wear and aging.

Notes

Bosch Rexroth AG
Hydraulics
Zum Eisengießer 1
97816 Lohr am Main, Germany
Phone +49 (0) 93 52/18-0
documentation@boschrexroth.de
www.boschrexroth.de

© This document, as well as the data, specifications and other information set forth in it, are the exclusive property of Bosch Rexroth AG. It may not be reproduced or given to third parties without its consent.
The data specified above only serve to describe the product. No statements concerning a certain condition or suitability for a certain application can be derived from our information. The information given does not release the user from the obligation of own judgment and verification.
It must be remembered that our products are subject to a natural process of wear and aging.

Notes

