

Pressure reducing valve, direct operated

RE 26564/05.11
Replaces: 02.03

1/8

Type DR 6 DP

Size 6
Component series 5X
Maximum operating pressure 315 bar [4568 psi]
Maximum flow 60 l/min [15.9 US gpm]



H7743

Table of contents

Contents	Page
Features	1
Ordering code	2
Symbols	2
Function, section	3
Technical data	4
Characteristic curves	5
Unit dimensions	6, 7

Features

- For subplate mounting
- Porting pattern according to DIN 24340 form A
- Porting pattern according to ISO 4401-03-02-0-05 and NFPA T3.5.1 R2-2002 D03 (**with** locating hole)
- 4 adjustment types for pressure adjustment, optionally:
 - Rotary knob
 - Setscrew with hexagon and protective cap
 - Lockable rotary knob with scale
 - Rotary knob with scale
- 5 pressure ratings
- Check valve, optional
- More informatio:
 - Subplates

Data sheet 45052

Information on available spare parts:
www.boschrexroth.com/spc

Ordering code

DR 6 DP	-5X/	Y				*
---------	------	---	--	--	--	---

Pressure reducing valve, direct operated, size 6

Adjustment type

Rotary knob	= 1
Setscrew with hexagon and protective cap	= 2
Lockable rotary knob with scale	= 3 ¹⁾
Rotary knob with scale	= 7
Component series 50 to 59 (50 to 59: Unchanged installation and connection dimensions)	= 5X
Maximum secondary pressure 25 bar [362 psi]	= 25
Maximum secondary pressure 75 bar [1088 psi]	= 75
Maximum secondary pressure 150 bar [2175 psi]	= 150
Maximum secondary pressure 210 bar [3046 psi]	= 210
Maximum secondary pressure 315 bar [4568 psi]	= 315 ²⁾

Further details in the plain text

No code = Without locating hole
/60³⁾ = With locating hole
/62 = With locating hole and locating pin ISO 8752-3x8-St

Seal material

No code = NBR seals
V = FKM seals
 (other seals upon request)
 Attention!
 Observe compatibility of seals with hydraulic fluid used!

No code = With check valve
M = Without check valve

Y = Pilot oil supply internal, leakage oil discharge external

- ¹⁾ H-key with Material no. **R900008158** is included in the delivery.
- ²⁾ Only with adjustment type "2" and without check valve
- ³⁾ Locating pin ISO 8752-3x8-St, Material no. **R900005694** (separate order)

Standard types and standard units are contained in the EPS (standard price list).

Symbols

Version "M"
without check valve

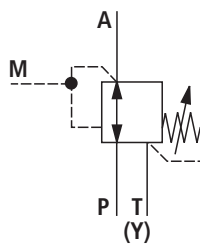

"No code" version
with check valve

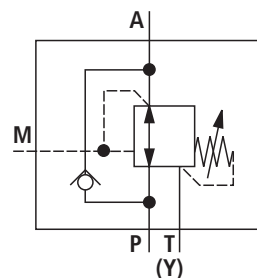

Function, section

The valve type DR 6 DP is a direct operated pressure reducing valve in 3-way design, i.e. with pressure limitation of the secondary circuit.

It is used to reduce a system pressure. The secondary pressure is set via the adjustment type (4).

In the initial position the valve is open. Hydraulic fluid can flow from channel P to channel A without obstructions. Via the pilot line (6), the pressure in channel A is applied to the spool face vis-à-vis the compression spring (3). If the pressure in channel A rises above the value set at the compression spring (3), the control spool (2) moves into the control position and holds the set pressure in channel A constant.

Signal and pilot oil are provided internally, via the control line (6) by channel A.

If the pressure in channel A continues to increase due to external forces at the actuator, it moves the control spool (2) further against the compression spring (3).

Thus, channel A is, via the control edge (8) at the control spool (2), connected with channel T(Y). Hydraulic fluid flows to the tank until the pressure can only increase slightly.

The leakage oil drain from the spring chamber (7) is always realized externally, via channel T(Y).

For the free flow back from channel A to channel P, you can optionally install a check valve (5).

A pressure gauge connection (1) allows for the control of the secondary pressure.

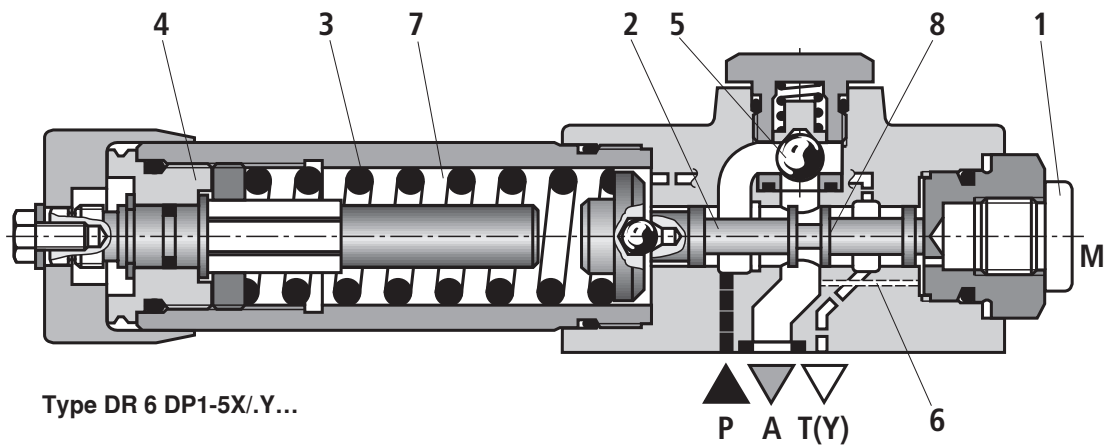

Technical Data (For applications outside these parameters, please consult us!)**general**

Weight	kg [lbs]	1.2 [2.64]
Installation position		Any
Ambient temperature range	°C [°F]	-30 to +80 [-22 to +176] (NBR seals) -20 to +80 [-4 to +176] (FKM seals)

hydraulic

Maximum operating pressure – Port P	bar [psi]	315 [4568]
Maximum secondary pressure – Port A	bar [psi]	25; 75; 150; 210; 315 [362; 1088; 2175; 3046; 4568]
Maximum backpressure – Port T (Y)	bar [psi]	160 [2320]
Maximum flow	l/min [US gpm]	60 [15.9]
Hydraulic fluid		See table below
Hydraulic fluid temperature range	°C [°F]	-30 to +80 [-22 to +176] (NBR seals) -20 to +80 [-4 to +176] (FKM seals)
Viscosity range	mm ² /s [SUS]	10 to 800 [60 to 3710]
Maximum permitted degree of contamination of the hydraulic fluid - cleanliness class according to ISO 4406 (c)		Class 20/18/15 ¹⁾

Hydraulic fluid	Classification	Suitable sealing materials	Standards
Mineral oils and related hydrocarbons	HL, HLP, HLPD	NBR, FKM	DIN 51524
Environmentally compatible – Insoluble in water	HETG	NBR, FKM	ISO 15380
	HEES	FKM	
– Soluble in water	HEPG	FKM	ISO 15380
– Water-free	HFUD, HFDR	FKM	ISO 12922
Flame-resistant – Water-containing	HFC (Fuchs Hydrotherm 46M, Petrofer Ultra Safe 620)	NBR	ISO 12922

Important information on hydraulic fluids!

- For more information and data on the use of other hydraulic fluids refer to data sheet 90220 or contact us!
- There may be limitations regarding the technical valve data (temperature, pressure range, service life, maintenance intervals, etc.)!

– Flame-resistant – water-containing:

- Maximum operating pressure 210 bar
- Maximum hydraulic fluid temperature 60 °C
- Expected service life as compared to HLP hydraulic oil 30 % to 100 %

¹⁾ The cleanliness classes specified for the components must be adhered to in hydraulic systems. Effective filtration prevents faults and at the same time increases the service life of the components.

For the selection of the filters see www.boschrexroth.com/filter.

Characteristic curves (measured with HLP46, $\vartheta_{\text{Oil}} = 40 \pm 5 \text{ }^\circ\text{C}$ [$104 \pm 9 \text{ }^\circ\text{F}$])

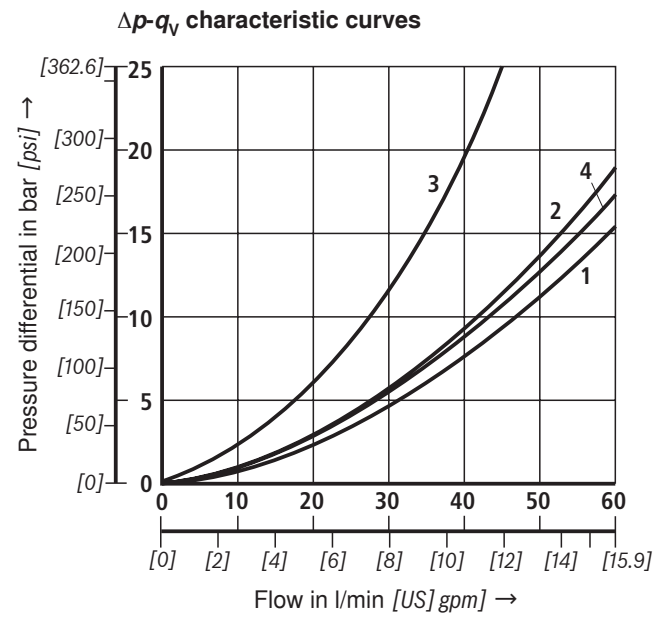
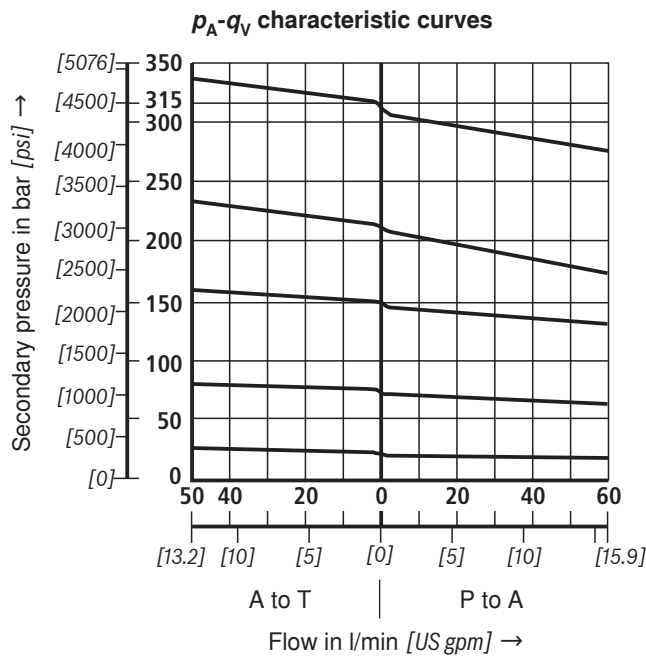

Note!

With lower pressures set, the curve development is maintained according to the pressure rating.

The characteristic curves apply to the pressure at the valve output $p = 0$ bar across the entire flow range.

- 1 P to A (minimum pressure differential)
- 2 A to T(Y) (minimum pressure differential)
- 3 Δp only via check valve
- 4 Δp via check valve and completely opened control cross-section

Unit dimensions (dimensions in mm [inch])

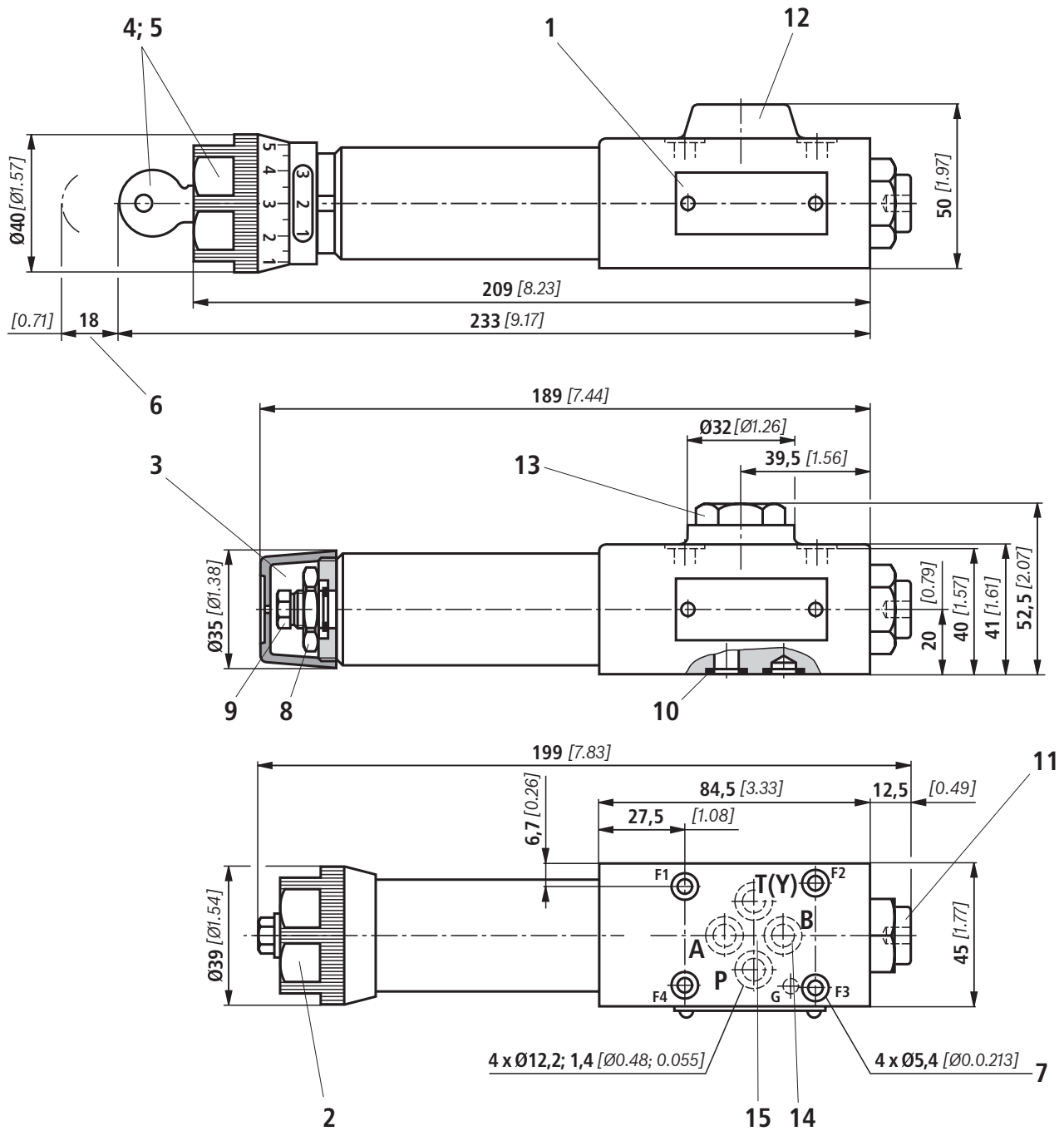

Explanations of items, valve mounting screws and sub-plates see page 7.

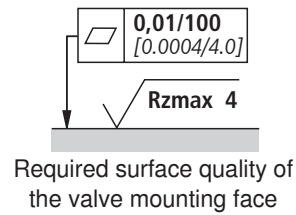

Unit dimensions

- | | |
|--|--|
| <p>1 Name plate</p> <p>2 Adjustment type "1"</p> <p>3 Adjustment type "2"</p> <p>4 Adjustment type "3"</p> <p>5 Adjustment type "7"</p> <p>6 Space required to remove the key</p> <p>7 Valve mounting bores</p> <p>8 Lock nut SW24</p> <p>9 Hexagon SW10</p> <p>10 Identical seal rings for ports A, B, P, T(Y)</p> <p>11 Pressure gauge connection G1/4, 12 deep.
Internal hexagon SW6</p> <p>12 Without check valve</p> <p>13 With check valve</p> <p>14 Port B without function</p> <p>15 Porting pattern according to DIN 24340 form A
(without locating hole), or ISO 4401-03-02-0-05 and
NFPA T3.5.1 R2-2002 D03 (with locating hole for lo-
cating pin ISO 8752-3x8-St,
Material no. R900005694, separate order)</p> | <p>Subplates according to data sheet 45052 (separate order)</p> <p>(without locating hole) G 341/01 (G1/4)
G 342/01 (G3/8)
G 502/01 (G1/2)</p> <p>(with locating hole) G 341/60 (G1/4)
G 342/60 (G3/8)
G 502/60 (G1/2)</p> <p>Valve mounting screws (separate order)</p> <p>4 hexagon socket head cap screws metric
ISO 4762 - M5 x 50 - 10.9-fIZn-240h-L
with friction coefficient $\mu_{\text{total}} = 0.09$ to 0.14,
Tightening torque $M_A = 7 \text{ Nm} \pm 10 \%$,
Material no. R913000064</p> <p>4 hexagon socket head cap screws UNC
10-24 UNC x 2" (on request)</p> |
|--|--|

Notes

Bosch Rexroth AG
Hydraulics
Zum Eisengießer 1
97816 Lohr am Main, Germany
Phone +49 (0) 93 52 / 18-0
Fax +49 (0) 93 52 / 18-23 58
documentation@boschrexroth.de
www.boschrexroth.de

© This document, as well as the data, specifications and other information set forth in it, are the exclusive property of Bosch Rexroth AG. It may not be reproduced or given to third parties without its consent. The data specified above only serve to describe the product. No statements concerning a certain condition or suitability for a certain application can be derived from our information. The information given does not release the user from the obligation of own judgment and verification. It must be remembered that our products are subject to a natural process of wear and aging.