

## 4/2 and 4/3 Directional Control Valve, Solenoid Operated

### RPE3-06

Size 06 (D03) • Q<sub>max</sub> 80 l/min (21 GPM) • p<sub>max</sub> 350 bar (5100 PSI)

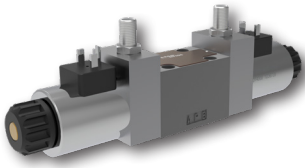

#### Technical Features

- › Direct acting, directional control valve with subplate mounting interface acc. to ISO 4401, DIN 24340 (CETOP 03)
- › High transmitted hydraulic power up to 350 bar with optimized design to minimize pressure drop
- › Five chamber housing design with reduced hydraulic power dependence on fluid viscosity
- › The valve is available with interchangeable DC solenoids, also for AC power supply using a built-in rectifier bridge
- › Wide range of solenoid electrical terminal versions available
- › Wide range of interchangeable spools and manual overrides available
- › CSA Certificate upon request
- › Inductive contactless Normally Open and Normally Closed spool position sensor option
- › Soft-shift spool speed control option
- › The coil is fastened to the core tube with a retaining nut and can be rotated by 360° to suit the available space
- › In the standard version, the valve housing is phosphated. The steel parts are zinc coated (240 h corrosion protection in NSS acc. to ISO 9227)
- › With optional increased surface corrosion protection of the whole valve 520 h in NSS, e.g. for mobile applications

#### ISO 4401-03-02-0-05

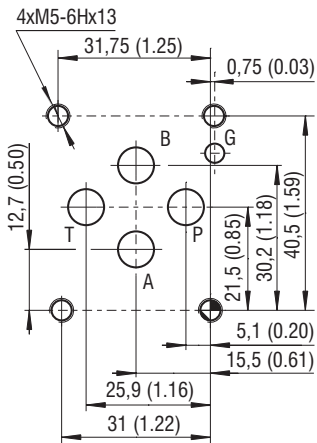

Ports P, A, B, T - max Ø7.5 mm (0.29 in)

#### Technical Data

Valve size	06 (D03)		
Max. flow	80 (21.1)		
Max. operating pressure at ports P, A, B	bar (PSI)	standard 350 (5080)	
		320 (4640) acc. to CSA	
Max. operating pressure at port T	bar (PSI)	210 (3050)	
Fluid temperature range (NBR)	°C (°F)	-30 ... +80 (-22 ... +176)	
Fluid temperature range (FPM)	°C (°F)	-20 ... +80 (-4 ... +176)	
Ambient temperature range	°C (°F)	-30 ... +50 (-22 ... +122)	
Supply voltage tolerance	%	AC: ±10	DC: ±10
Max. switching frequency	1/h	15 000	
Switching time at v=32 mm/s (156 SUS)	ON	ms	AC: 30 ... 40      DC: 30 ... 50
	OFF	ms	AC: 30 ... 70      DC: 10 ... 50
Weight	- valve with 1 solenoid	kg (lbs)	1.6 (3.52)
	- valve with 2 solenoids		2.2 (4.85)
General information		Datasheet	Type
		GI_0060	Products and operating conditions
Coil types / connectors		C_8007 / K_8008	C22B* / K*
Mounting interface		SMT_0019	Size 06
Spare parts		SP_8010	

#### Characteristics measured at v = 32 mm<sup>2</sup>/s (156 SUS)

##### Operating limits

Operating limits for maximum hydraulic power at rated temperature and supply voltage equal to 90 % nominal.

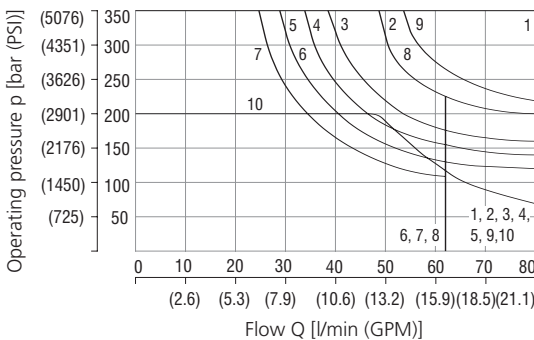

Spool symbol	5	F11	7	Z91
1	Z11			
6	C11	R11	5	R31
5	H11	R21	5	H51
1	P11	A51	7	F51
2	Y11	P51	3	X11
5	L21	Y51	7	K11
8	B11	C51	7	N11
6	Y41	Z51	10	X25
1	Z21	Z71	1	J15
5	C41	Z81	9	J75

##### Pressure drop related to flow rate

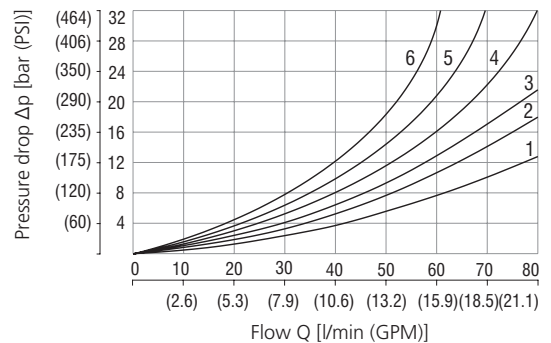

Spool symbol	P-A	P-B	A-T	B-T	P-T	P-A	P-B	A-T	B-T	P-T
Z11,L21,B11,R11	2	2	3	3		P51	1	3		
R21,X11,N11,J15						Y51	2	2		
C11	5	5	5	6	3	C51	2		3	4
H11	2	2	2	3	3	Z71	3	3		
P11	1	1	3	3		Z81		3	3	
Y11	2	2	2	2		Z91	3		3	3
Y41	3	3	3	3		R31	2		3	
Z21,Z51,H51		2	3			F51	2	3		
C41	4	4			5	K11	2	3		
F11	1	2		3	3	X25	3	3	3	
A51,J75	2	2								

For operating limits under conditions and flow directions other than shown contact our technical support. Admissible operating limits may be considerably lower with only one direction of flow (A or B plugged, or without flow.)

## Ordering Code

**RPE3 - 06** [ ] [ ] / [ ] [ ] [ ] [ ] [ ] [ ] [ ] [ ] [ ] [ ]

**4/2 and 4/3 directional control valve, solenoid operated**

**Valve size**

**Number of spool positions**  
two positions **2**  
three positions **3**

**Spool symbols**  
see the table "Spool Symbols"

**Rated supply voltage of solenoids**  
(at the coil terminals)

12 V DC / 2.72 A	☉ <b>01200</b>
24 V DC / 1.29 A	☉ <b>02400</b>
27 V DC / 1.07 A	<b>02700</b>
205 V DC / 0.15 A	<b>20500</b>
24 V AC / 1.56 A / 50 (60 Hz)	<b>02450</b>
120 V AC / 0.26 A / 60 Hz	☉ <b>12060</b>
230 V AC / 0.15 A / 50 (60) Hz	☉ <b>23050</b>

☉ CSA upon request - only for 320 bar (4640 PSI)

**Connector**  
EN 175301-803-A  
E1 with quenching diode  
AMP Junior Timer - axial direction (2 pins; male)  
E3A with quenching diode  
EN 175301-803-A with integrated rectifier  
Loose conductors (two insulated wires)  
E8 with quenching diode  
Deutsch DT04-2P - axial direction (2 pins; male)  
E12A with quenching diode

☉ **E1**  
**E2**  
**E3A**  
**E4A**  
☉ **E5**  
**E8**  
**E9**  
**E12A**  
**E13A**

**No designation**  
**U**

**CSA Certified**  
standard  
CSA marking

**Surface treatment**  
standard  
**A** zinc-coated (ZnCr-3), ISO 9227 (240 h)  
**B** zinc-coated (ZnNi), ISO 9227 (520 h)

**Spool monitoring**  
without sensors  
normally-open sensor  
normally-closed sensor

**Seals**  
NBR  
FPM (Viton)

**Soft-shift spool speed control**  
without soft-shift control  
orifice  $\varnothing$  0.7 mm (0.03 inch) in solenoid

**Manual override**  
standard  
cap nut covered  
rubber boot protected  
detent assembly  
hand screw  
socket head screw  
without manual override

**No designation**  
**S1**  
**S4**

**No designation**  
**V**

**No designation**  
**T1**

**No designation**  
**N1**  
**N2**  
**N3**  
**N4**  
**N5**  
**N9**

- For directional valves with two solenoids, one solenoid must be de-energized before the other solenoid can be charged.
- For AC voltage supply use coils with connector type E5.
- For other solenoid voltage supply options see data sheet C\_8007.
- The solenoid operated valves are delivered without connectors. For available connectors see data sheet K\_8008.
- The orifice to the P port can be ordered separately, see data sheet SP\_8010.
- Mounting bolts M5 x 45 DIN 912-10.9 or studs must be ordered separately. Tightening torque is 8.9 Nm (6.56 lbf.ft).
- Besides the commonly used valve versions shown other special models are available. Contact our technical support for their identification, feasibility and operating limits.

## Spool Symbols

Type	Symbol	Interposition	Type	Symbol	Interposition	Type	Symbol	Interposition
Z11			R11			Z11		
C11			R21			X11		
H11			A51			C11		
P11			P51			H11		
Y11			Y51			K11		
L21			C51			N11		
B11			Z51			F11		
Y41			Z71			X25		
Z21			Z81			J15		
C41			Z91			J75		
F11			R31					
			H51					
			F51					

### Solenoid Coil in millimeters (inches)

E1, E2 Protection degree IP65	E3A, E4A Protection degree IP67	E5 Protection degree IP65	E8, E9 Protection degree IP65	E12A, E13A Protection IP67 / 69K
The indicated IP protection level is only achieved if the connector is properly mounted.				

### Manual Override in millimeters (inches)

No designation - standard	Designation N1 - cap nut covered	Designation N2 - rubber boot protected	Designation N3 - detent assembly	Designation N4 - hand screw	Designation N5 - socket head screw, size 3	Designation N9 - without manual override

In case of solenoid malfunction or power failure, the spool of the valve can be shifted by manual override as long as the pressure in port T does not exceed 25 bar (363 PSI). For alternative manual overrides contact our technical support.

### Spool Position Sensor

**S1** - Circuit diagram for the normally - **OPEN** sensor

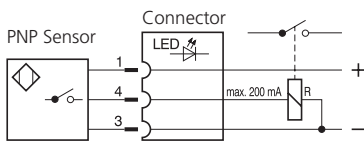

**S4** - Circuit diagram of the normally - **CLOSED** sensor

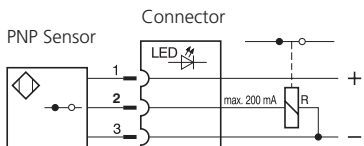

#### Function of the position sensor:

In the basic position (when the solenoid is switched off), a steel core, connected to the spool, is under the position sensor. The sensor is activated, it means contacts of the sensor S1 are closed and contacts of the sensor S4 are open. After switching on the solenoid the spool with core moves out of the sensor range and the sensor is deactivated.

Technical Data of the Sensor		S1, S4
Rated power supply voltage	V	24 DC
Power supply voltage range	V	10 ... 30 DC
Rated current	mA	200
Sensor enclosure protection (EN 60529)		IP 67
Max. operating pressure at port T	bar (PSI)	210 (3046)
Switching frequency	Hz	1000
Ambient temperature range	°C (°F)	-25 ... +80 (-13 ... +176)
Technical Data of the Connector		
Power supply voltage range	V	10 ... 30 DC
Ambient temperature range	°C (°F)	-25 ... +80 (-13 ... +176)
Indicator		yellow LED

#### Typical configurations of the valve with a sensor:

- 3-position valve with two solenoids, equipped with two sensors
- 2-position valve with one solenoid, equipped with one sensor on the solenoid side
- 2-position valve with a detent assembly of spool, equipped with one sensor on the side of the solenoid which moves the spool from the basic position to the switched position according to the spool symbol

**Note:** the sensor always indicates the change of spool position realised by the energised solenoid, mounted on the side of the sensor.

① Signal of solenoid ③ Signal of sensor	Two-Position Directional Control Valve				
	① a(b)		③ Sa(Sb)		LED
	S1	S4	S1	S4	
0	1	0	ON	OFF	
1	0	1	OFF	ON	

Three-Position Directional Control Valve									
① a(b)		③ Sa(Sb)				LED			
		S1		S4		S1		S4	
a	b	Sa	Sb	Sa	Sb	Sa - LED	Sb - LED	Sa - LED	Sb - LED
0	0	1	1	0	0	ON	ON	OFF	OFF
1	0	0	1	1	0	OFF	ON	ON	OFF
0	1	1	0	0	1	ON	OFF	OFF	ON

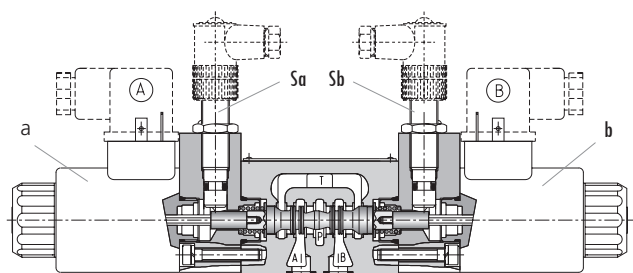
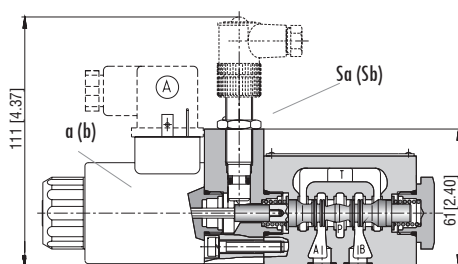

**Spool Speed Control** in millimeters (inches)

<b>Designation T1</b>	<b>Important:</b>
	<p>This directional valve provides the means to control spool soft shifting by an orifice situated in the solenoid armature. To ensure the proper function of the valve, unobstructed venting of the solenoid is required through the bleeding plug (1). The plugs are accessible after removing the rubber boot (2) from the solenoid cap nut (3).</p>
Switching time ON and OFF	300 ... 800 ms
<p>The switching times shown are valid for viscosity <math>\nu = 32 \text{ mm}^2/\text{s}</math> (156 SUS) and nominal voltage. They depend on working pressure and flow rate of the directional control valve.</p>	

**Dimensions** in millimeters (inches)

**Valve with two solenoids**

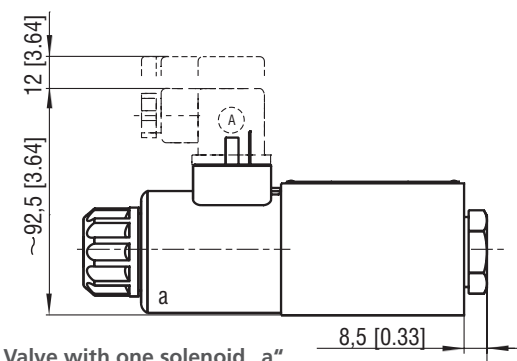
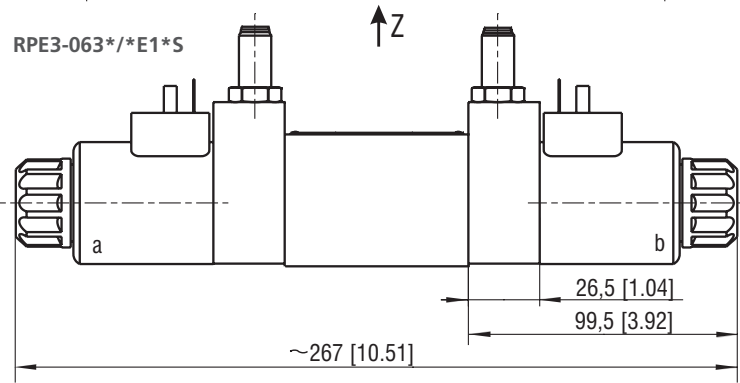
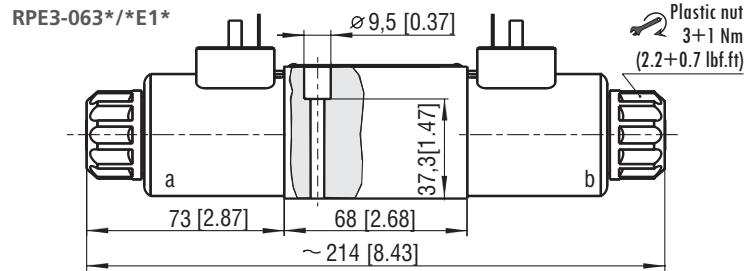
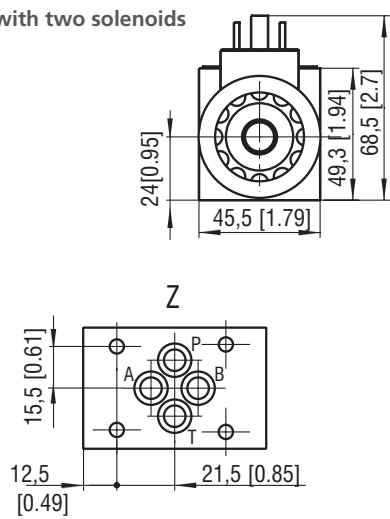

**Valve with one solenoid „a“**

Spool symbols R11, R21, A51, P51, Y51, Z51, C51, R31, Z71, Z81, Z91, H51, F51, X25

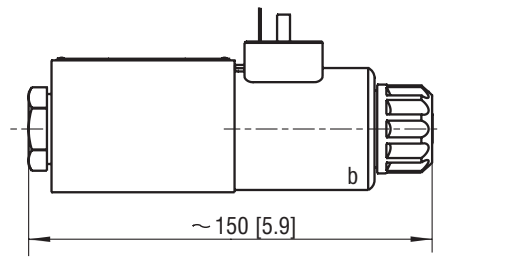
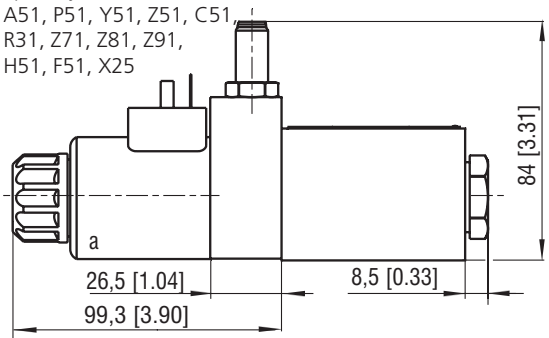

**Valve with one solenoid „b“**

Spool symbols X11, Z11, C11, H11, K11, N11, F11

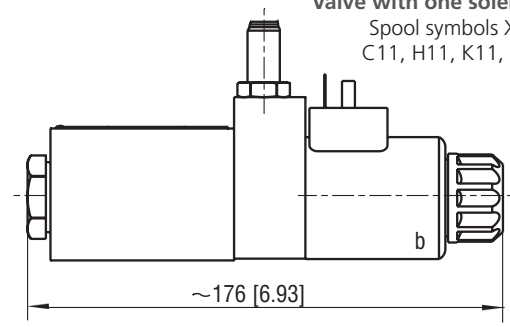

Mounting screws 8.9 Nm (7 lbf.ft)  
M5x45 DIN 912-10.9